

## HP10 MULTIMATIC

<b>Product code</b>	IN0AKF332050700
<b>Reactive power Ue=400V</b>	300 kvar
<b>Reactive power Ue=415V</b>	320 kvar
<b>Nominal voltage Ue</b>	400-415V
<b>Capacitors voltage Un</b>	415 V
<b>Capacitors max voltage Umax</b>	455 V
<b>Frequency</b>	50 Hz
<b>THDI<sub>R</sub>%</b>	≤12%
<b>THDIC%</b>	≤50%
<b>Steps</b>	2x30-4x60 kvar
<b>Electrical steps number</b>	10
<b>Banks</b>	2x150 kvar
<b>Load break switch</b>	800 A
<b>Icc</b>	50 kA
<b>Controller</b>	8BGA
<b>IP degree</b>	IP4X
<b>Dimensions WxDxH</b>	610x670x1760mm
<b>Weight</b>	190 kg

NOTE Icc value: Other values upon request.

### Standard features

<b>Max current overload I<sub>n</sub></b>	1.3 I <sub>n</sub> 1,3 I <sub>n</sub> (continuous) 2 I <sub>n</sub> (x380s every 60 minutes) 3 I <sub>n</sub> (x150s every 60 minutes) 4 I <sub>n</sub> (x70s every 60 minutes) 5 I <sub>n</sub> (x45s every 60 minutes)
<b>Max current overload I<sub>n</sub> (capacitors)</b>	
<b>Max overload V<sub>n</sub></b>	1,1xU <sub>e</sub>
<b>Max overload V<sub>n</sub> (capacitors)</b>	3xUn (for 1 minute)
<b>Insulation voltage</b>	690V
<b>Temperature class</b>	-5/+40°C
<b>Temperature class (capacitors)</b>	-25/+55°C
<b>Discharge device</b>	mounted on each bank
<b>Installation</b>	indoor
<b>Service</b>	continuous
<b>Internal connection</b>	delta
<b>Total losses</b>	~ 2W/kvar
<b>Inner surface finish</b>	zinc passivation
<b>Standards (bank)</b>	IEC 61439-1/2, IEC 61921
<b>Standards (capacitors)</b>	IEC 60831-1/2

## Generalities

Zink-passivated metallic enclosure painted with epossidic dust paint, colour RAL 7035.

Auxiliary transformer to separate power and auxiliary circuit parts (110V).

Load-break switch with door interlock.

Special contactors with damping resistors to limit capacitors inrush current (AC6b).

FS17 450/750V self-extinguish cable according to EN 50525 - EN 50575 - EN 50575/A1.

Microprocessor Power Factor Correction relay.

CRM25 single phase self-healing metallized polypropylene capacitor with  $U_n=415V$  rated voltage.



Bottom view  
ground fixing and  
cables entry

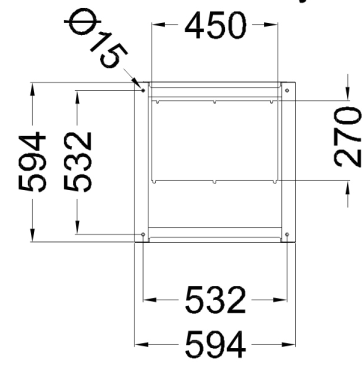

Top view

