

## FH20-60HZ-400V MULTIMATIC

<b>Product code</b>	IN7AFF330060701
<b>Reactive power Ue=400V</b>	300 kvar
<b>Nominal voltage Ue</b>	400V
<b>Capacitors voltage Un</b>	550 V
<b>Capacitors max voltage Umax</b>	600 V
<b>Frequency</b>	60 Hz
<b>THDI<sub>R</sub>%</b>	100%
<b>I<sub>250Hz</sub>%</b>	≤25%
<b>THDV<sub>R</sub>%</b>	≤6%
<b>Detuning frequency f<sub>D</sub></b>	216 Hz
<b>Steps</b>	20-40-3x80 kvar
<b>Electrical steps number</b>	15
<b>Banks</b>	60-3x80 kvar
<b>Load break switch</b>	800 A
<b>I<sub>cc</sub></b>	50 kA
<b>Controller</b>	8BGA
<b>IP degree</b>	IP4X
<b>Dimensions WxDxH</b>	610x670x1960mm
<b>Weight</b>	373 kg

NOTE I<sub>cc</sub> value: Other values upon request.

### Standard features

<b>Max current overload I<sub>n</sub></b>	1.3 I <sub>n</sub>
<b>Max current overload I<sub>n</sub> (capacitors)</b>	1,3 I <sub>n</sub> (continuous)
<b>Max overload V<sub>n</sub></b>	1,1xU <sub>e</sub>
<b>Max overload V<sub>n</sub> (capacitors)</b>	3xU <sub>n</sub> (for 1 minute)
<b>Insulation voltage</b>	690V
<b>Temperature class</b>	-5/+40°C
<b>Temperature class (capacitors)</b>	-25/+55°C
<b>Discharge device</b>	mounted on each bank
<b>Installation</b>	indoor
<b>Service</b>	continuous
<b>Internal connection</b>	delta
<b>Total losses</b>	~ 6W/kvar
<b>Inner surface finish</b>	zinc passivation
<b>Standards (bank)</b>	IEC 61439-1/2, IEC 61921
<b>Standards (capacitors)</b>	IEC 60831-1/2

## Generalities

Zink-passivated metallic enclosure painted with epossidic dust paint, colour RAL 7035.

Auxiliary transformer to separate power and auxiliary circuit parts (110V).

Load-break switch with door interlock.

Contactors for capacitive loads.

FS17 450/750V self-extinguish cable according to EN 50525 - EN 50575 - EN 50575/A1.

Microprocessor Power Factor Correction relay.

Control and protection multimeter MCP5, integrated in 8BGA controller.

CRM25 single phase self-healing metallized polypropylene capacitor with  $U_n=550V-50Hz$  (480-V60Hz) rated voltage.

Three phase detuning choke with tuning frequency  $f_D=216Hz$  ( $N=3.6-p\%=7.7\%$ ).

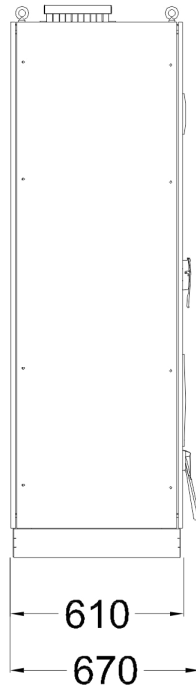
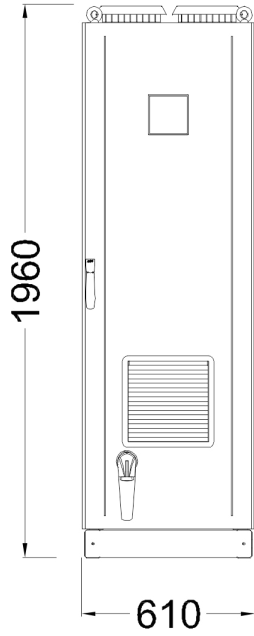

Bottom view  
ground fixing and  
cables entry

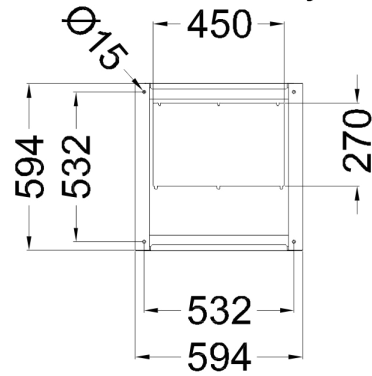

Top view

