

HP10-60HZ-230V MULTIMATIC

Product code	IN0ABB327060700
Reactive power Ue=230V	270 kvar
Nominal voltage Ue	230V
Capacitors voltage Un	415 V
Capacitors max voltage Umax	455 V
Frequency	60 Hz
THDI_R%	≤20%
THDIC%	≤70%
Steps	2x27-4x54 kvar
Electrical steps number	10
Banks	30-4x60 kvar
Load break switch	2x800 A
Icc	50 kA
Controller	8BGA
IP degree	IP4X
Dimensions WxDxH	1220x670x1760mm
Weight	500 kg

NOTE Icc value: Other values upon request.

Standard features

Max current overload In	1.3 In
Max current overload In (capacitors)	1,3 In (continuous)
Max overload Vn	1,1xUe
Max overload Vn (capacitors)	3xUn (for 1 minute)
Insulation voltage	690V
Temperature class	-5/+40°C
Temperature class (capacitors)	-25/+55°C
Discharge device	mounted on each bank
Installation	indoor
Service	continuous
Internal connection	delta
Total losses	~ 2W/kvar
Inner surface finish	zinc passivation
Standards (bank)	IEC 61439-1/2, IEC 61921
Standards (capacitors)	IEC 60831-1/2

Generalities

Zink-passivated metallic enclosure painted with epossidic dust paint, colour RAL 7035.

Auxiliary transformer to separate power and auxiliary circuit parts (110V).

Load-break switch with door interlock.

Special contactors with damping resistors to limit capacitors inrush current (AC6b).

FS17 450/750V self-extinguish cable according to EN 50525 - EN 50575 - EN 50575/A1.

Microprocessor Power Factor Correction relay.

CRM25 single phase self-healing metallized polypropylene capacitor with $U_n=415V-50Hz$ (350V60Hz) rated voltage.

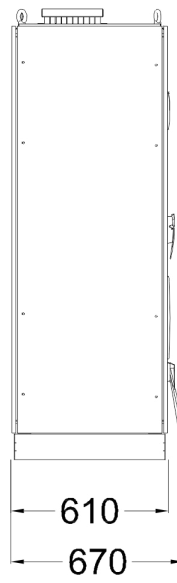
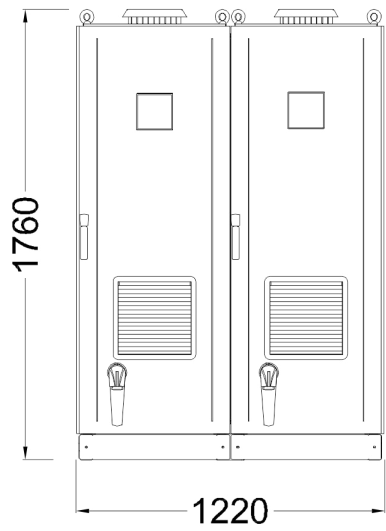

Bottom view
ground fixing and
cables entry

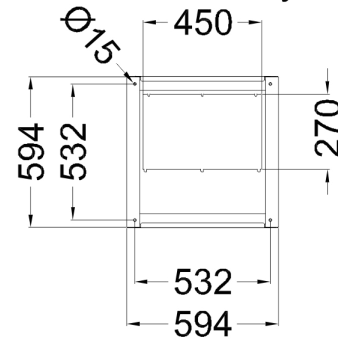

Top view

