

FH20-60HZ-230V MULTIMATIC

Product code	IN7ABB318860701
Reactive power Ue=230V	188 kvar
Nominal voltage Ue	230V
Capacitors voltage Un	415 V
Capacitors max voltage Umax	455 V
Frequency	60 Hz
THDI_R%	100%
I_{250Hz}%	≤25%
THDV_R%	≤6%
Detuning frequency f_D	216 Hz
Steps	12.5-25-3x50 kvar
Electrical steps number	15
Banks	37.5-3x50 kvar
Load break switch	800 A
Icc	50 kA
Controller	8BGA
IP degree	IP4X
Dimensions WxDxH	610x670x1960mm
Weight	380 kg

NOTE Icc value: Other values upon request.



This image is indicative only.

Standard features

Max current overload I_n	1.3 I _n
Max current overload I_n (capacitors)	1,3 I _n (continuous)
Max overload V_n	1,1xU _e
Max overload V_n (capacitors)	3xU _n (for 1 minute)
Insulation voltage	690V
Temperature class	-5/+40°C
Temperature class (capacitors)	-25/+55°C
Discharge device	mounted on each bank
Installation	indoor
Service	continuous
Internal connection	delta
Total losses	~ 6W/kvar
Inner surface finish	zinc passivation
Standards (bank)	IEC 61439-1/2, IEC 61921
Standards (capacitors)	IEC 60831-1/2

Generalities

Zink-passivated metallic enclosure painted with epossidic dust paint, colour RAL 7035.

Auxiliary transformer to separate power and auxiliary circuit parts (110V).

Load-break switch with door interlock.

Contactors for capacitive loads.

FS17 450/750V self-extinguish cable according to EN 50525 - EN 50575 - EN 50575/A1.

Microprocessor Power Factor Correction relay.

Control and protection multimeter MCP5, integrated in 8BGA controller.

CRM25 single phase self-healing metallized polypropylene capacitor with $U_n=415V-50Hz$ (315V-60Hz) rated voltage.

Three phase detuning choke with tuning frequency $f_D=216Hz$ ($N=3.6-p\%=7.7\%$).

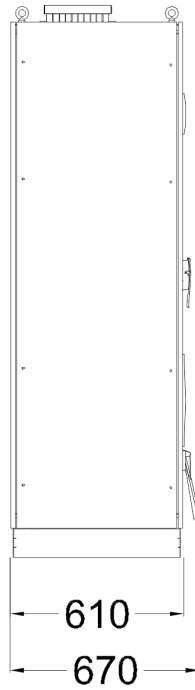
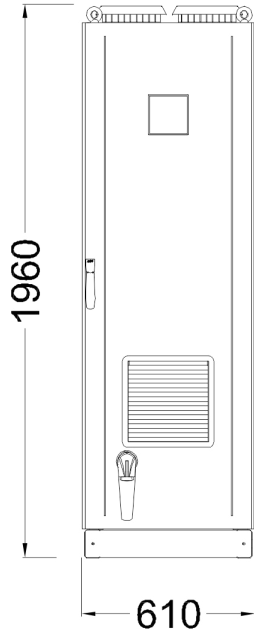

Bottom view
ground fixing and
cables entry

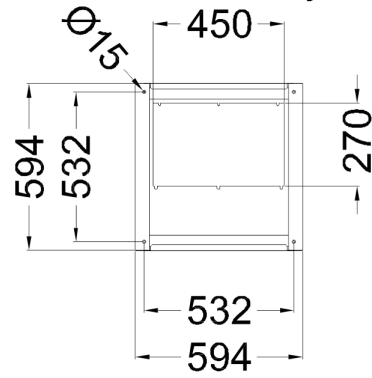

Top view

