

FH20.S MULTIMATIC IP55

Product code	IV7AFF328050786
Reactive power Ue=400V	280 kvar
Reactive power Ue=415V	300 kvar
Nominal voltage Ue	400-415V
Capacitors voltage Un	550 V
Capacitors max voltage Umax	600 V
Frequency	50 Hz
THDI_R%	100%
I_{250Hz}%	≤25%
THDV_R%	≤6%
Detuning frequency f_D	180 Hz
Steps	40-3x80 kvar
Electrical steps number	7
Banks	40-3x80 kvar
Load break switch	630 A
Icc	25 kA
Controller	8BGA
IP degree	IP55
Dimensions WxDxH	822x670x1960mm
Weight	415 kg

NOTE Icc value: Other values upon request.

Standard features

Max current overload I_n	1.3 I _n 1,3 I _n (continuous) 2 I _n (x380s every 60 minutes) 3 I _n (x150s every 60 minutes) 4 I _n (x70s every 60 minutes) 5 I _n (x45s every 60 minutes)
Max current overload I_n (capacitors)	
Max overload V_n	1,1xU _e
Max overload V_n (capacitors)	3xU _n (for 1 minute)
Insulation voltage	690V
Temperature class	-5/+40°C
Temperature class (capacitors)	-25/+55°C
Discharge device	mounted on each bank
Installation	indoor
Service	continuous
Internal connection	delta
Total losses	~ 6W/kvar
Inner surface finish	zinc passivation
Standards (bank)	IEC 61439-1/2, IEC 61921
Standards (capacitors)	IEC 60831-1/2

Generalities

Zink-passivated metallic enclosure painted with epossidic dust paint, colour RAL 7035.

Auxiliary transformer to separate power and auxiliary circuit parts (110V).

Load-break switch with door interlock.

Thyristor switches (SCR).

Total switching time 60 milliseconds.

FS17 450/750V self-extinguish cable according to EN 50525 - EN 50575 - EN 50575/A1.

Microprocessor Power Factor Correction relay.

Control and protection multimeter MCP5, integrated in 8BGA controller (MIDImatic and MULTImatic version).

CRM25 single phase self-healing metallized polypropylene capacitor with $U_n=550V$ rated voltage.

Three phase detuning choke with tuning frequency $f_D=180Hz$ ($N=3.6-p\%=7.7\%$).

Min. distance from the wall: 250mm

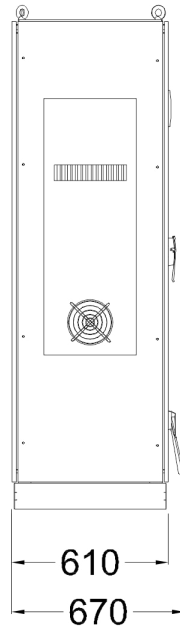
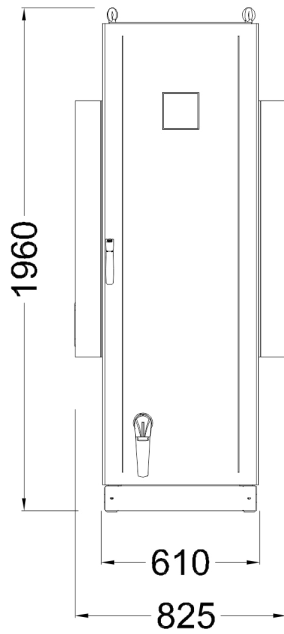

Bottom view
ground fixing and
cables entry

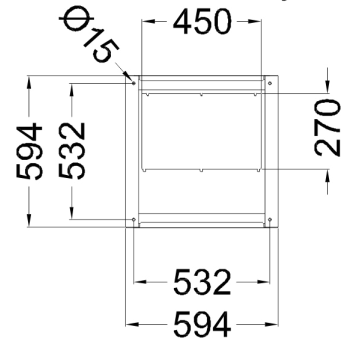

Top view

