

VP20 MULTIMATIC

Product code	IN2ZLF378450700
Reactive power Ue=400V	587 kvar
Reactive power Ue=415V	628 kvar
Reactive power Un=460V	784 kvar
Nominal voltage Ue	400-415V
Capacitors voltage Un	460 V
Capacitors max voltage Umax	500 V
Frequency	50 Hz
THDI_R%	≤27%
THDIC%	≤90%
Steps	53-5x106 kvar
Electrical steps number	11
Banks	31-9x62 kvar
Load break switch	2x800 A
Icc	50 kA
Controller	8BGA
IP degree	IP4X
Dimensions WxDxH	1220x670x2160mm
Weight	820 kg

NOTE Icc value: Other values upon request.

Standard features

Max current overload I_n	1.3 I _n
Max current overload I_n (capacitors)	1,3 I _n (continuous) 2 I _n (x500s every 60 minutes) 3 I _n (x180s every 60 minutes) 4 I _n (x90s every 60 minutes) 5 I _n (x50s every 60 minutes)
Max overload V_n	1,1xU _e
Max overload V_n (capacitors)	3xU _n (for 1 minute)
Insulation voltage	690V
Temperature class	-5/+40°C
Temperature class (capacitors)	-25/+70°C
Discharge device	mounted on each bank
Installation	indoor
Service	continuous
Internal connection	delta
Total losses	~ 2W/kvar
Inner surface finish	zinc passivation
Standards (bank)	IEC 61439-1/2, IEC 61921
Standards (capacitors)	IEC 60831-1/2

Generalities

Zink-passivated metallic enclosure painted with epossidic dust paint, colour RAL 7035.

Auxiliary transformer to separate power and auxiliary circuit parts (110V).

Load-break switch with door interlock.

Special contactors with damping resistors to limit capacitors inrush current (AC6b).

FS17 450/750V self-extinguish cable according to EN 50525 - EN 50575 - EN 50575/A1.

Microprocessor Power Factor Correction relay.

CRM25 single phase self-healing metallized polypropylene capacitor with increased thickness and $U_n=460V$ rated voltage.

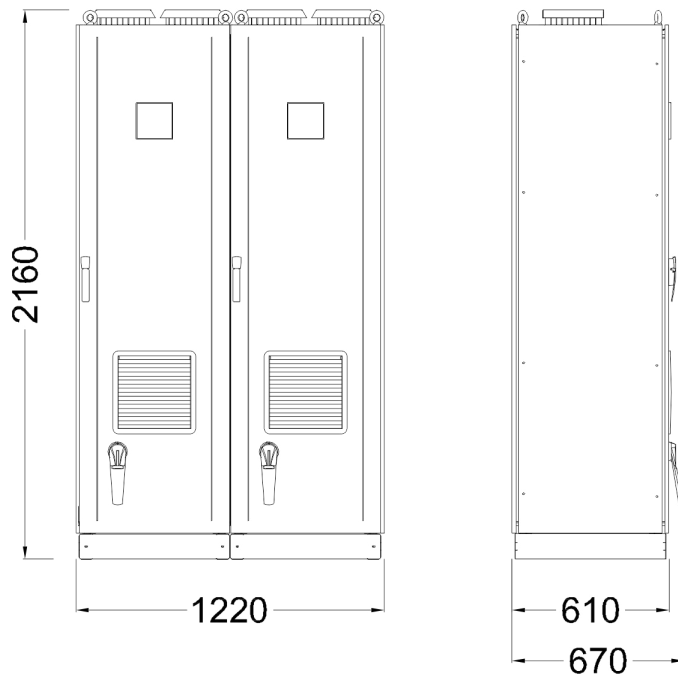

Bottom view
ground fixing and
cables entry

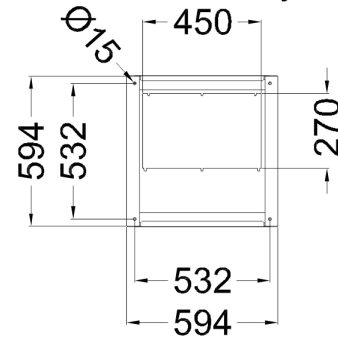

Top view

